

# INDEX

*better.parts.faster.*



# German Turning Solutions Made for and in Thailand

VDW Symposium on March 24, 2026

Dr. Dirk Prust  
President of INDEX-Group

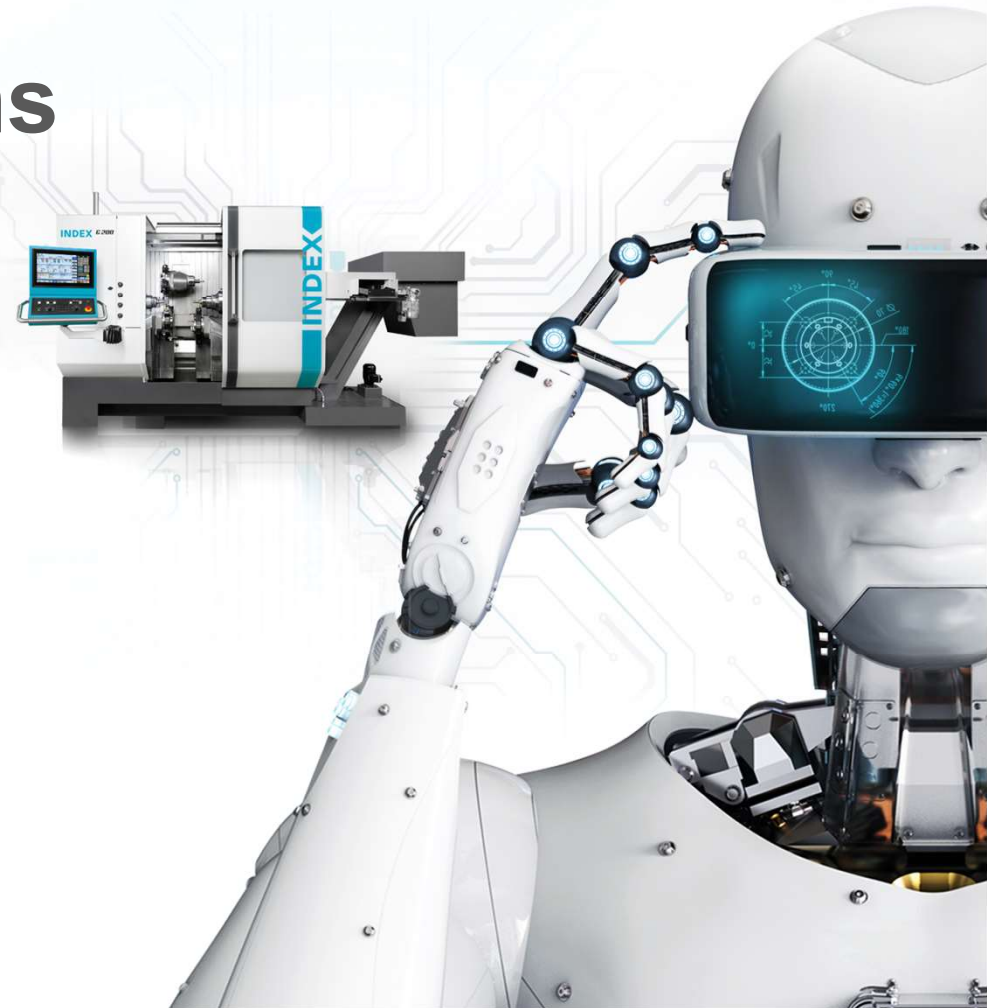

The logo for INDEX, consisting of the word "INDEX" in a bold, blue, sans-serif font.

- 1914** Founded by Hermann Hahn
- 1971** 40,000th cam-controlled single-spindle automatic lathe
- 1983** World's first CNC turn-mill center
- 1985** World's first CNC multi-spindle automatic lathe
- 1997** Acquisition of TRAUB Drehmaschinen GmbH
- 2002** World's first CNC turn-grind center
- 2005** World's first virtual machine on board
- 2013** World's first Industry 4.0 platform on board (iXpanel)
- 2017** iXcenter – automation solutions
- 2018** iXworld – the world of digital integration
- 2020** World's most successful series application of parallel kinematics with over 2,000 machines (C series)
- 2021** Acquisition of One Click Metal GmbH (3D printing)
- 2022** Completion of the turn-mill program (G series)
- 2023** Sales cooperation with Makino
- 2025** Founding of INDEX Machine Tools Thailand

A black and white portrait of Hermann Hahn, the founder of INDEX, wearing a suit and a bow tie. The portrait is semi-transparent and overlaid on the background.

# INNOVATION

IS IN OUR DNA

## 2026

With its INDEX and TRAUB brands, the INDEX Group is one of the world's leading machine tool manufacturers for 112 years.

**TURNING MILLING AUTOMATION COMPLETE MACHINING**

# WORLDWIDE FOR YOUR SUCCESS

# INDEX

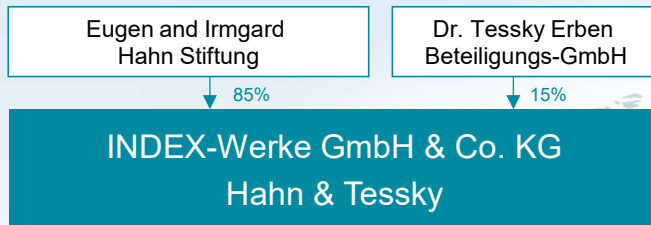

- ▶ 1,900 employees
- ▶ 6 production sites (+1 in Thailand, in planning)
- ▶ 13 sales and service companies
- ▶ Worldwide at over 80 locations

## INDEX-Werke

Esslingen  
Deizisau  
Reichenbach

One Click Metal  
Tamm

INDEX Nordic  
Spanga / Sweden

INDEX Poland  
Warsaw

INDEX Czech Republic  
Praha

INDEX Werkzeugmaschinen  
Vienna / Austria

INDEX Hungary  
Budapest

INDEX Slovakia  
Malacky / Slovakia

INDEX France  
Villebon-sur-Yvette  
Bonneville / France

INDEX Werkzeugmaschinen  
St. Blaise / Switzerland

INDEX Corporation  
Noblesville / USA

INDEX Trading  
Shanghai / China

INDEX Machine Tools  
Taicang / China

INDEX Machine Tools  
Bangalore / India

INDEX Machine Tools  
Rayong / Thailand

INDEX Tornos Automaticos  
Sorocaba / Brazil

*better.parts.faster.*

# REVENUE PERFORMANCE BY SEGMENT

**INDEX**

Group

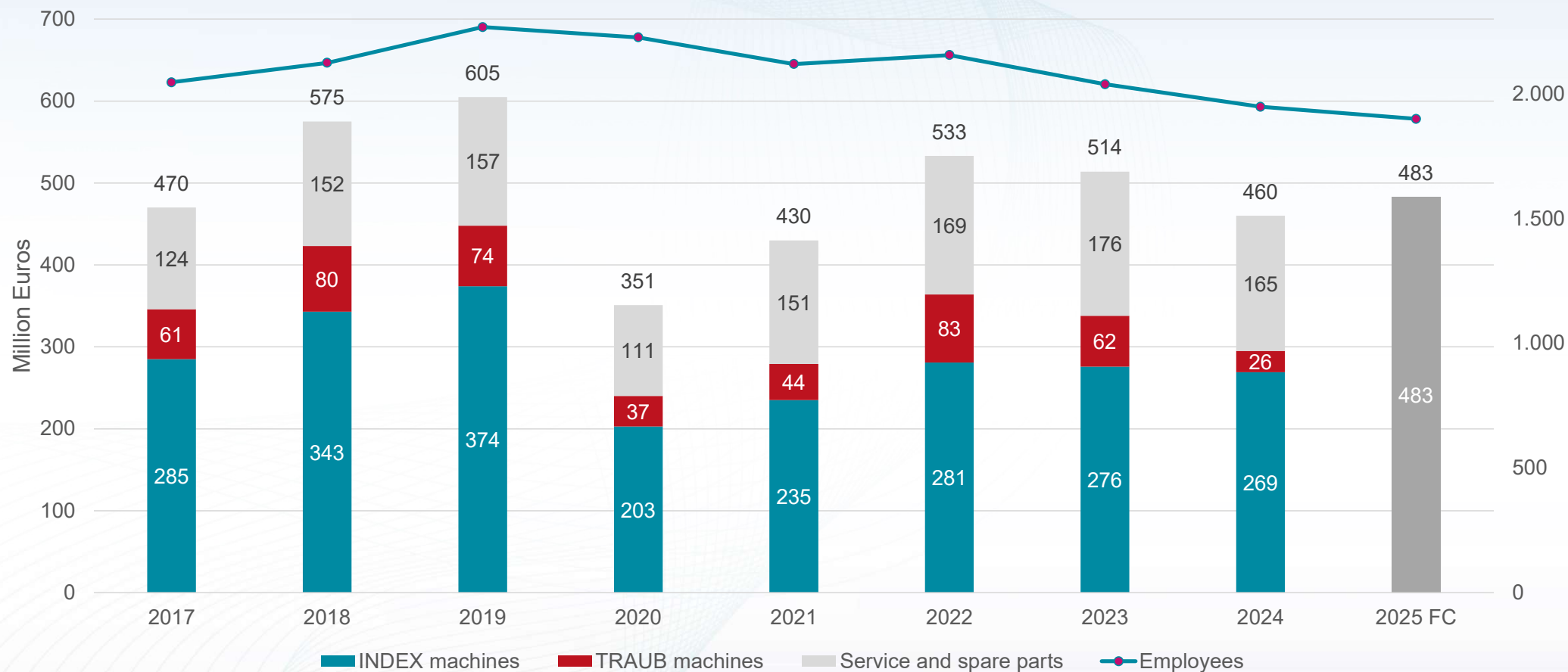

# REVENUE BY INDUSTRY 2025

## INDEX

## INDEX

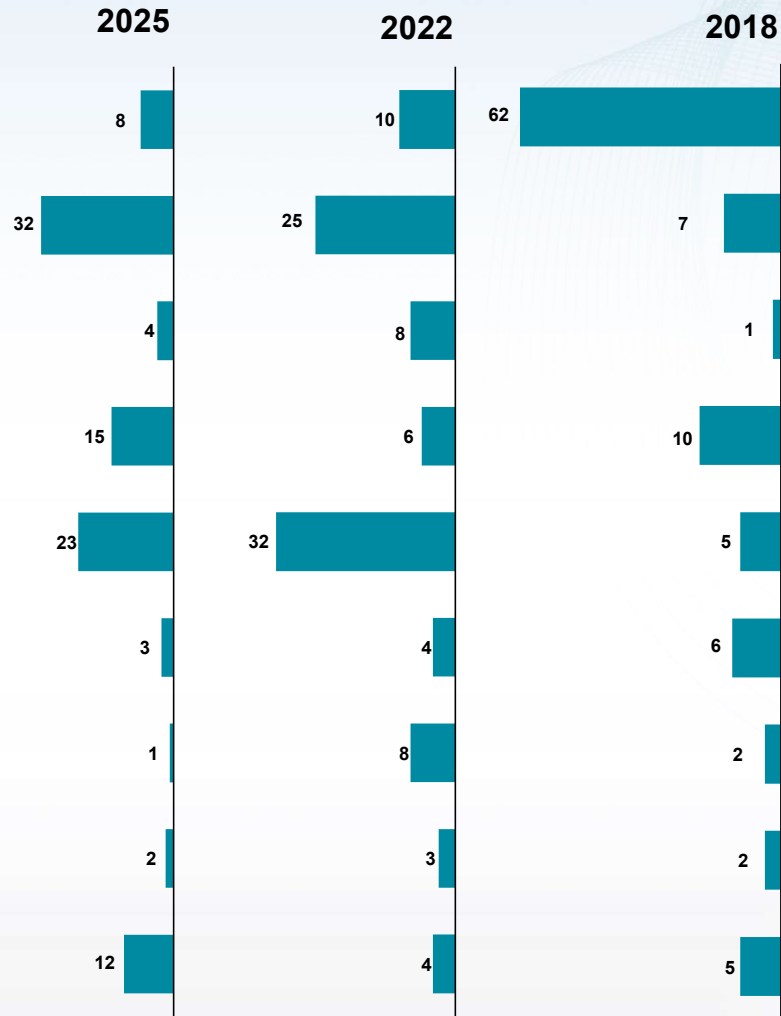

in %

## TRAUB

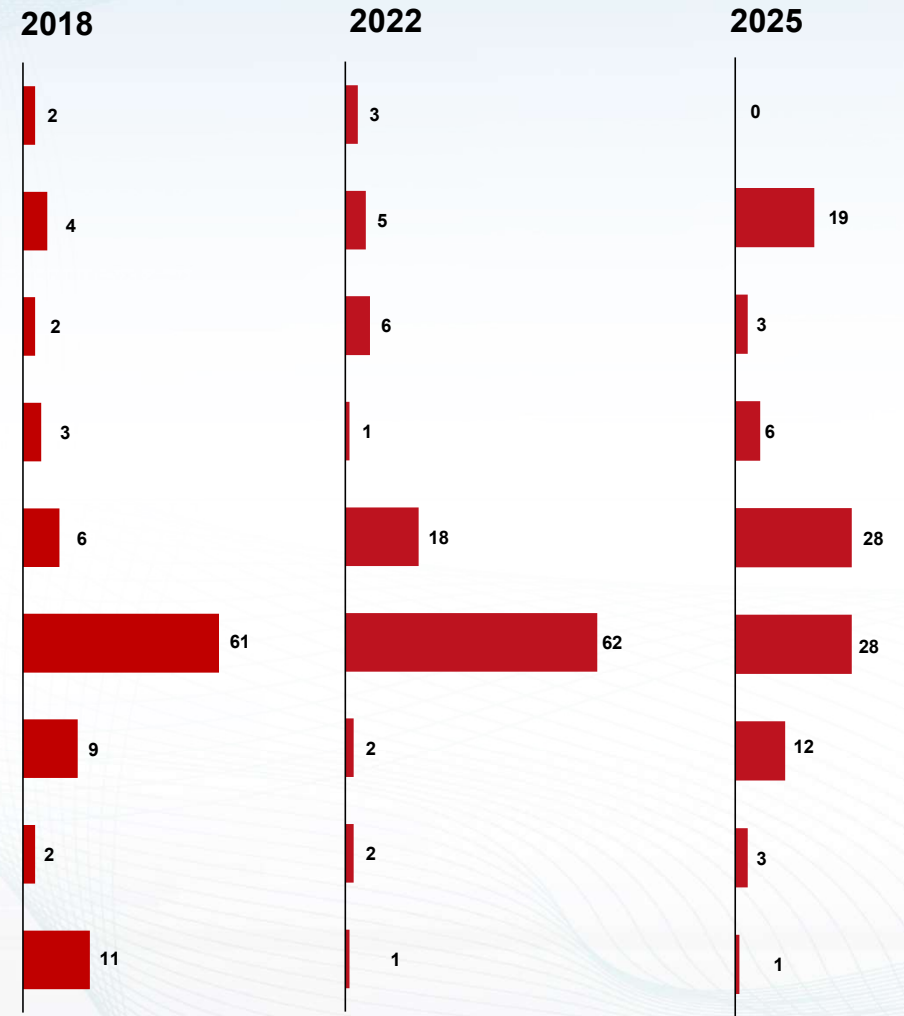

# DEVELOPED FOR TOP PERFORMANCE

# INDEX

**MECHANICAL  
ENGINEERING**

**MOBILITY  
SOLUTIONS**

**AEROSPACE  
SOLUTIONS**

**FITTINGS |  
FLUIDS**

**OPTICS |  
MICRO MECHANICS**

**MEDICAL  
SOLUTIONS**



# EFFICIENT USE OF TOP TECHNOLOGIES

# INDEX

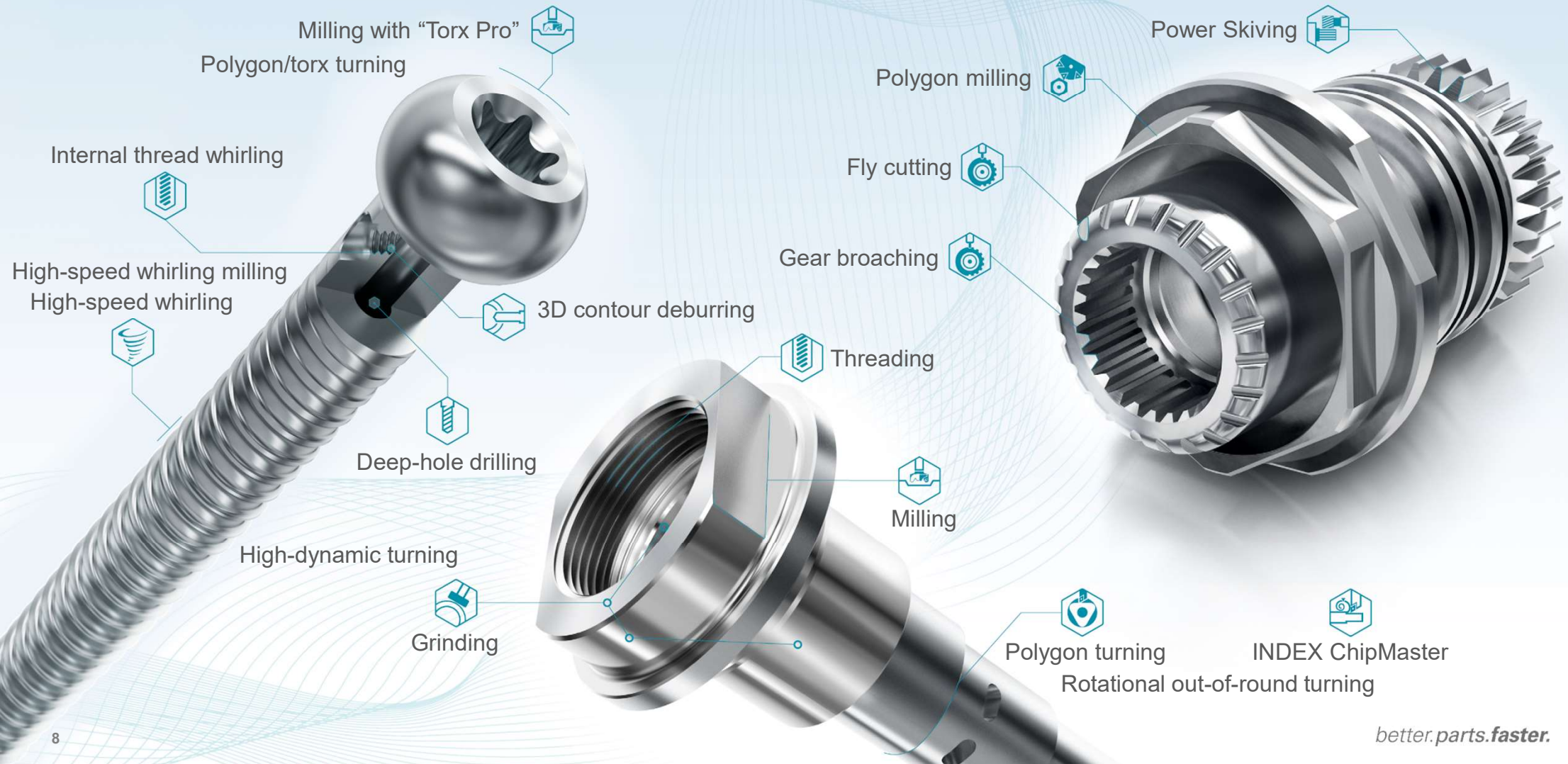

# INDEX TRAUB PRODUCT RANGE

**INDEX**



**UNIVERSAL  
LATHES**

**PRODUCTION  
LATHES**

**TURNING CENTERS |  
TURN-MILL CENTERS**

**SLIDING HEADSTOCK  
AUTOMATIC LATHES**

**MULTI-SPINDLE  
AUTOMATIC LATHES**

# PRODUCTION LATHES

**INDEX**

- ▶ Economical complete machining
- ▶ Highly productive thanks to simultaneous tool use
- ▶ Fast and optimized for bar and chuck machining



**INDEX ABC**



**INDEX C100**



**TRAUB TNK40**



**INDEX C200**

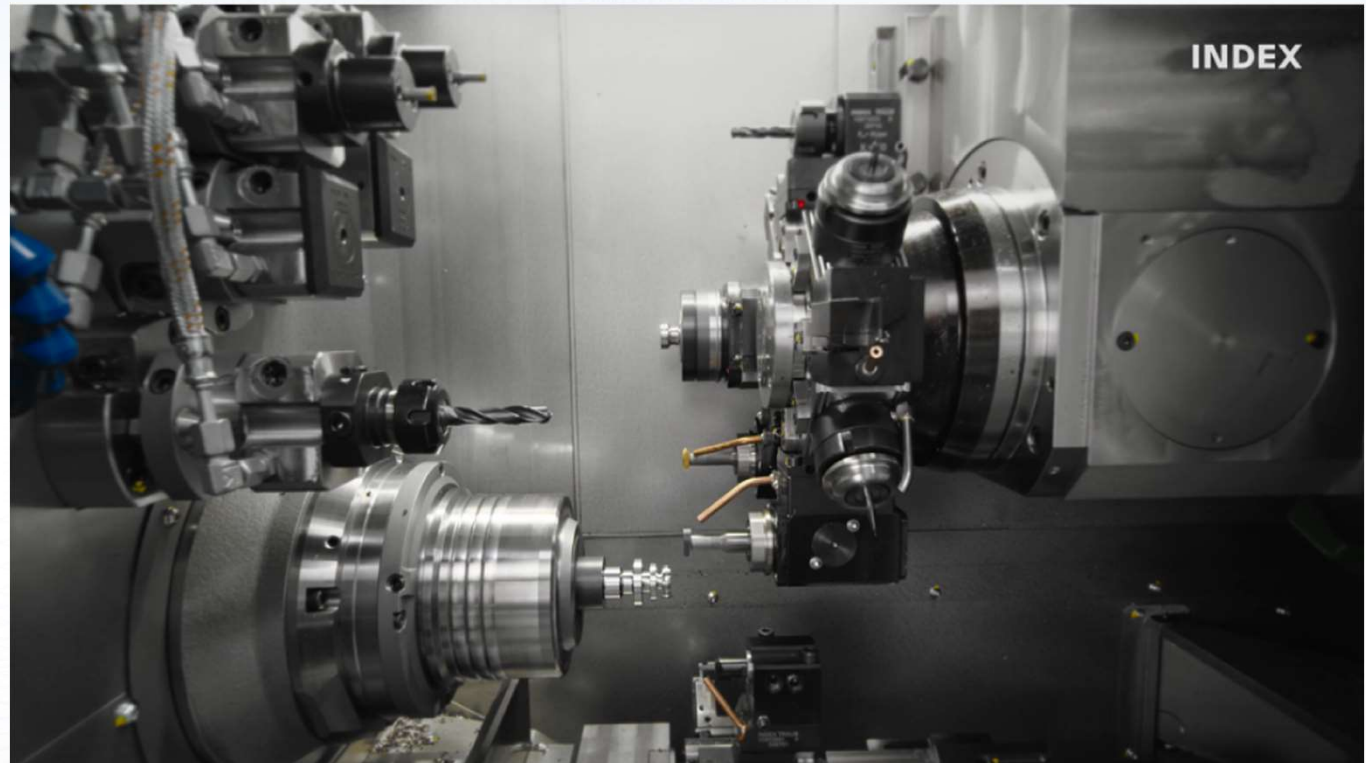

# TURNING CENTERS | TURN-MILL CENTERS

**INDEX**

- ▶ Economical complete machining
- ▶ Wide range of applications:  
Automotive  
Aerospace  
Mechanical engineering
- ▶ Flexible modular system
- ▶ iXtools additional magazine  
up to 392 tool locations



**INDEX G160**  
**INDEX G200, G220**  
**INDEX G300, G320**  
**INDEX G400, G420**  
**INDEX G500, G520**  
**INDEX R200, R300**  
**TRAUB TNX200, TNX220**  
**TRAUB TNX65**



# MULTI-SPINDLE AUTOMATIC LATHES

**INDEX**

- ▶ Highly productive due to two tool slides per spindle
- ▶ Efficient rear-end machining
- ▶ Short setup times

*INDEX MS16-6*  
*INDEX MS16-6 Plus*  
*INDEX MS24-6*  
*INDEX MS24-8*  
*INDEX MS32-6*  
*INDEX MS40-6*  
*INDEX MS40-8*  
*INDEX MS52-6*

*TRAUB MS12-4*

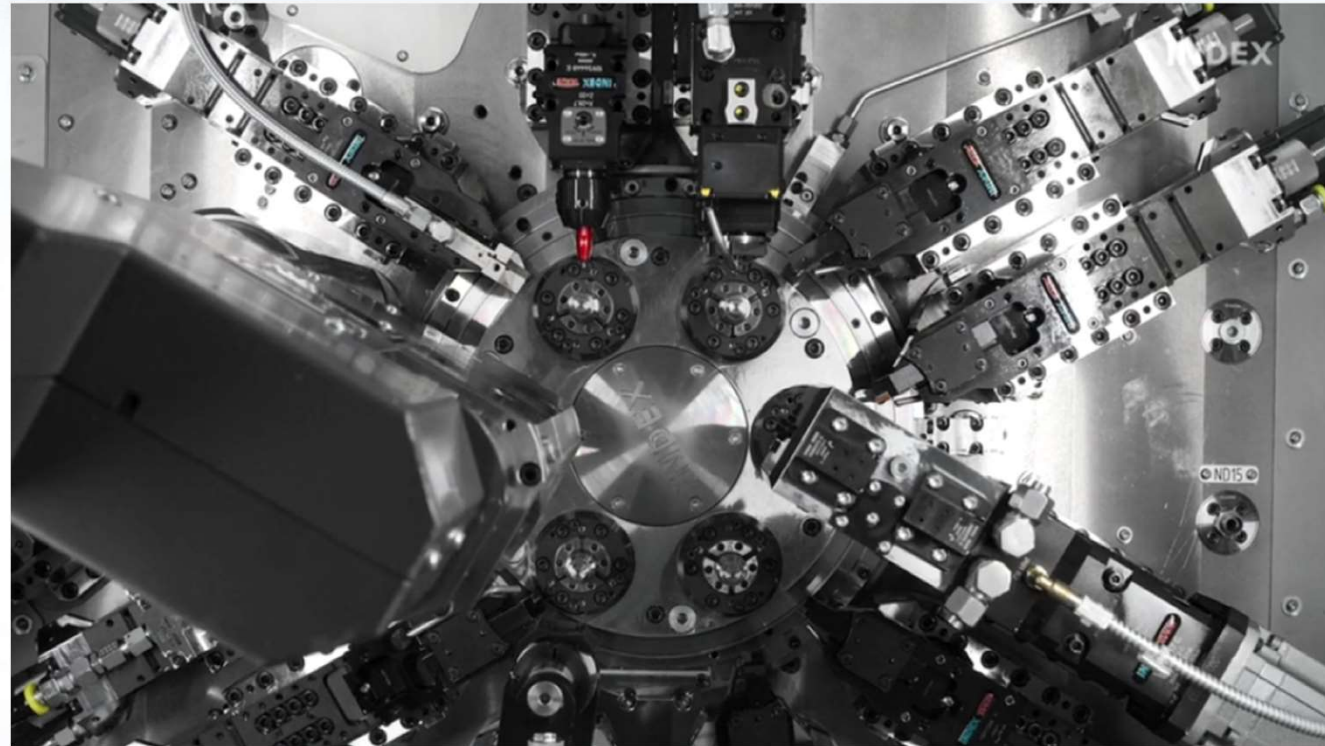

# AUTOMATION SOLUTIONS

INDEX



Intelligent workpiece handling from a single source

- ▶ Bar loading magazines
- ▶ Machine-integrated solutions
- ▶ Automated robot solutions
- ▶ Custom expansion options

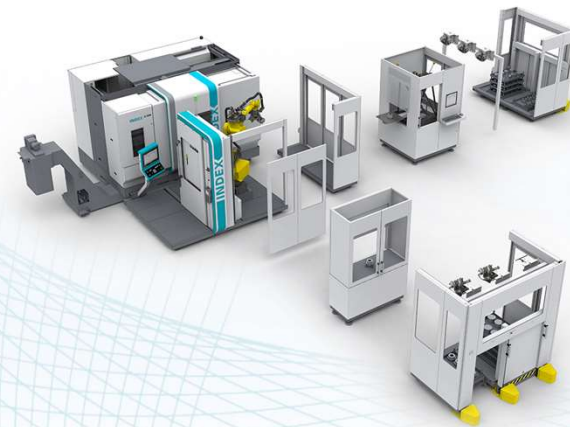



**INDEX**

**PRECISION**  
MADE BY INDEX

# IN-HOUSE PRODUCTION OF CORE COMPONENTS

**INDEX**

- ▶ All spindles, spindle drums, tool turrets, tool slides, and tool holders are **MADE BY INDEX**
- ▶ Focus on research and continuous technology development with **IN-HOUSE KNOW-HOW**
- ▶ Design, development and production at the INDEX sites

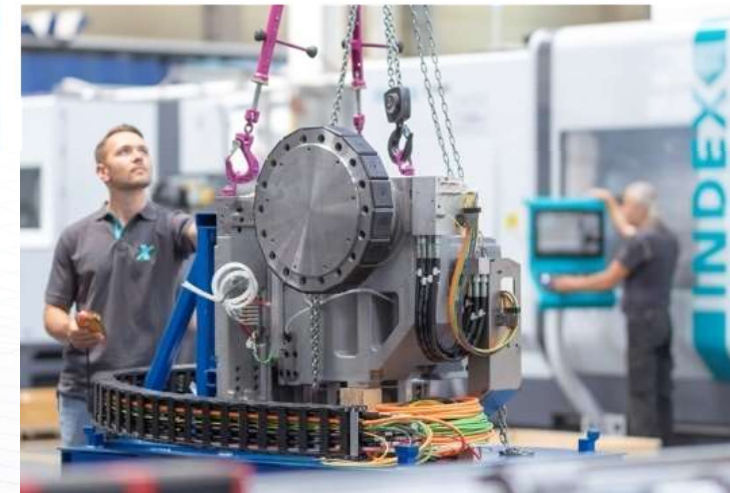
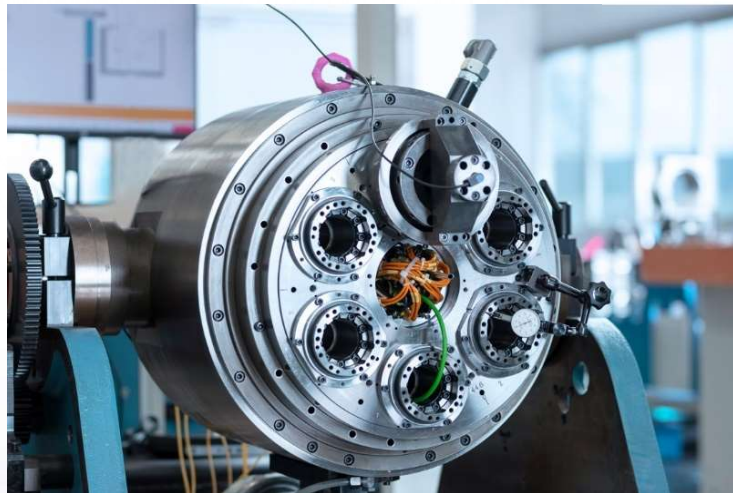

# EVERYTHING WE DO REVOLVES AROUND YOU

**INDEX**

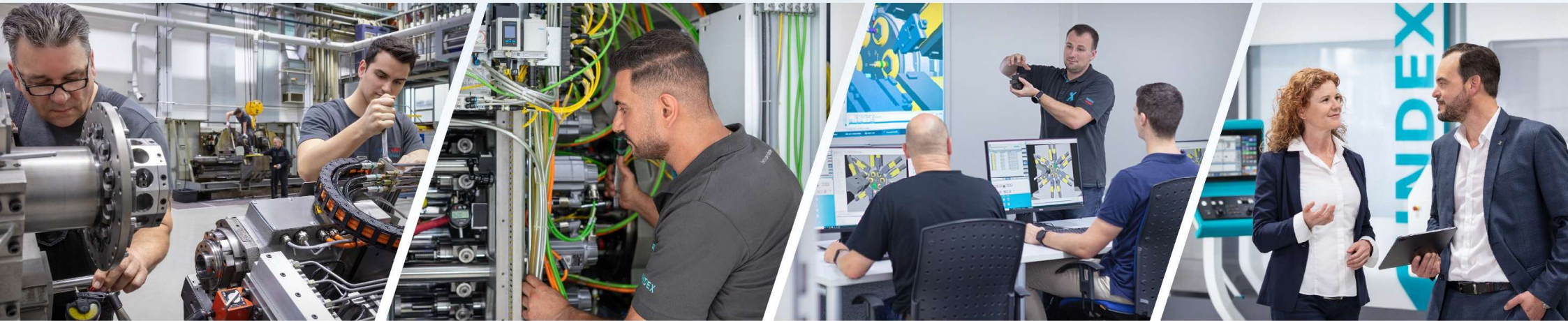

## Service products and refits

- ▶ Machine check
- ▶ Maintenance
- ▶ Component overhaul
- ▶ Complete overhaul

## Process support

- ▶ Setup
- ▶ Changeover
- ▶ Process optimization

## Training

- ▶ Professional, practical training
- ▶ Know-how relating to your INDEX and TRAUB machines
- ▶ Now also online

## Financing solutions

- ▶ Financing
- ▶ Performance rental model

# PRODUCTION OF TURNING MACHINES IN THAILAND

**INDEX**

- ▶ Production start of C200
- ▶ Engineered and produced in Thailand with high local content
  - ▶ Engineering
  - ▶ Manufacturing
  - ▶ Assembly
  - ▶ Commissioning
  - ▶ Quality Assurance

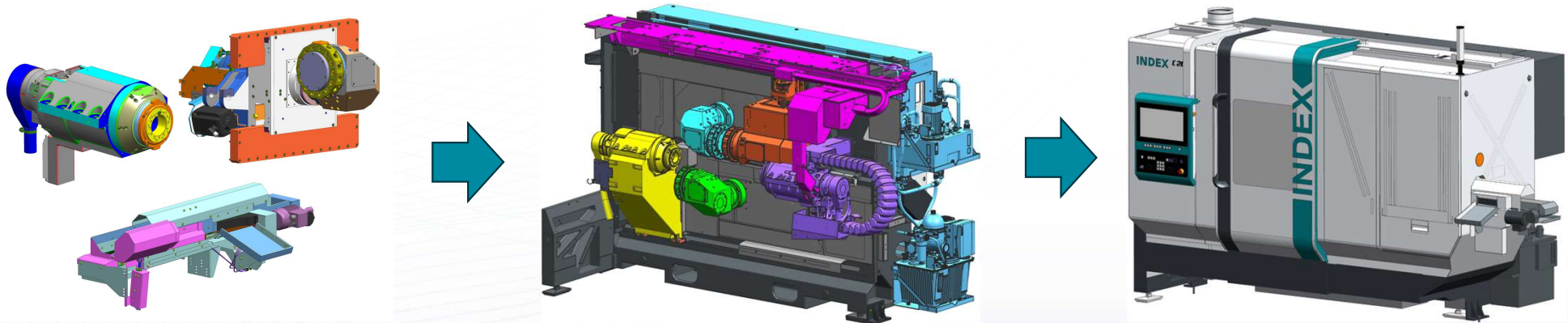

## PRODUCTION OF TURNING MACHINES IN THAILAND

**INDEX**



# PRODUCTION OF TURNING MACHINES IN THAILAND

INDEX

- ▶ Production area of 600 sqm (of 900 sqm in total)
- ▶ Capacity up to 30 machines per year
- ▶ Production for
  - ▶ domestic (Thailand, ASEAN) and
  - ▶ export market (Europe, Americas)

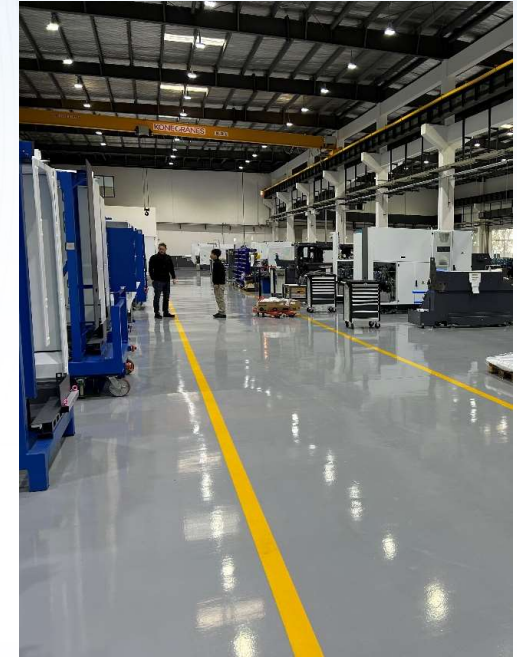

# NEW SUBSIDIARY: INDEX MACHINE TOOLS (THAILAND) CO., LTD.

**INDEX**

- ▶ Established in May 2025
- ▶ Start of operations in Q2 / 2026
- ▶ Managing Director: Mr. Oliver Prpic
- ▶ Located in Rayong, Eastern Seaboard Industrial Estate
- ▶ All in one place: Office, Showroom and Production
- ▶ Broad range of services
  - ▶ Sales
  - ▶ Service
  - ▶ Engineering
  - ▶ Production

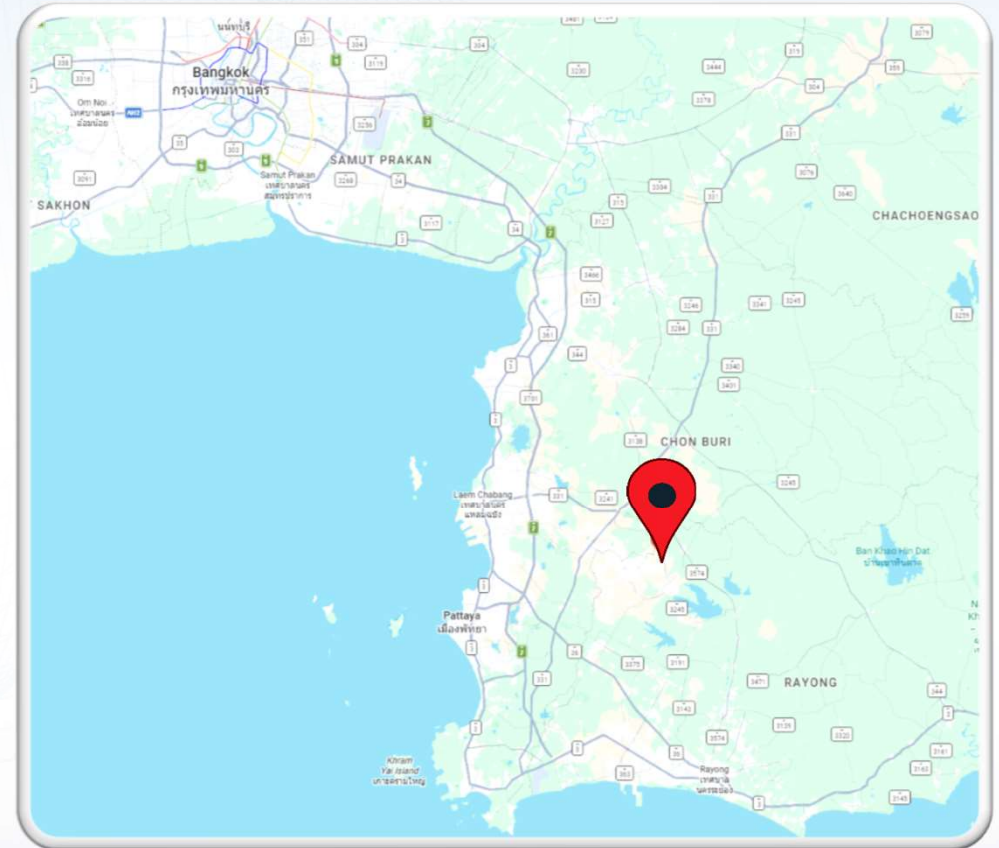

## THANK YOU FOR YOUR KIND ATTENTION

**Dr. Dirk Prust**  
CEO / CTO / COO  
Phone: +49 711 3191 208  
E-Mail: [dirk.prust@index-group.com](mailto:dirk.prust@index-group.com)

**INDEX-Werke GmbH & Co. KG Hahn & Tessky**  
Plochingen Strasse 92, 73730 Esslingen, Germany  
Phone +49 711 3191-0  
[info@index-group.com](mailto:info@index-group.com)  
[www.index-group.com](http://www.index-group.com)

Visit us on our social media channels:

